

*** PRELIMINARY REVISION FOR REFERENCE ***

DELTA ELECTRONICS, INC.
 252, SHANG YING ROAD, KUEI SAN
 TAOYUAN HSIEN 333, TAIWAN.

TEL : 886-(0)3-3591968
 FAX : 886-(0)3-3591991

SPECIFICATION FOR APPROVAL

Customer:

Description: GT FAN

Customer P/N: REV:

Delta Model NO.: GTB040PUD27R Safety Model NO.:

Sample Rev: X03 Issue NO:

Sample Issue Date: Quantity:

1. SCOPE:

THIS SPECIFICATION DEFINES THE ELECTRICAL AND MECHANICAL CHARACTERISTICS OF THIS CENTRIFUGAL FAN.

2. NOMINAL DATA:

UNLESS SPECIFIED, ALL READINGS AND TESTS ARE BASED ON 25 DEG C, 65% RH.

ITEM	DESCRIPTION
NOMINAL VOLTAGE	3 ϕ 400 VAC 50/60Hz
NOMINAL VOLTAGE RANGE	3 ϕ 380 - 480 VAC
INPUT POWER @ FREE-AIR	690 W
INPUT POWER @ MAX. LOAD	1000 W
INPUT CURRENT (MAX)	1.75 A
SPEED	2140 R.P.M. (REF.)
MAX. AIR FLOW (AT ZERO STATIC PRESSURE)	5270 (MIN. 4743) M ³ /H 3102 (MIN. 2792) CFM
MAX. AIR PRESSURE (AT ZERO AIR FLOW)	831.7 (MIN. 673.7) Pa 3.339 (MIN. 2.705) inchH ₂ O
ACOUSTICAL NOISE (AVG.) @ FREE-AIR	81.0 (MAX 86.0) dB(A)

- NOTES: 1. ALL READINGS ARE MEASURED AFTER STABLY WARMING UP THROUGH 10 MINUTES.
 2. THE VALUES WRITTEN IN PARENS , (), ARE LIMITED SPEC.
 3. ACOUSTICAL NOISE MEASURING CONDITION:

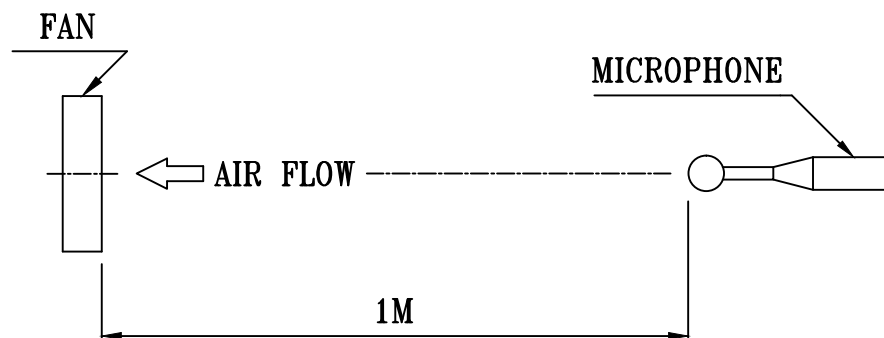

NOISE IS MEASURED AT NOMINAL VOLTAGE IN FREE AIR IN ANECHOIC CHAMBER WITH B & K SOUND LEVEL METER WITH MICROPHONE AT A DISTANCE OF ONE METER FROM THE FAN INTAKE.

*** PRELIMINARY REVISION FOR REFERENCE ***

PART NO:

DELTA MODEL: GTB040PUD27R

3. FEATURES:

DIRECTION OF ROTATION	CLOCKWISE, SEEN ON ROTOR
BEARING SYSTEM	BALL BEARINGS
WEIGHT	10.5 K.G. (REF.)
MATERIAL OF ELECTRONICS HOUSING	DIE-CAST ALUMINUM
MATERIAL OF IMPELLER	ALUMINUM SHEET
ELECTRICAL LEADS	VIA TERMINAL BLOCK
MOTOR PROTECTION	OVER TEMPERATURE PROTECTED
LEAKAGE CURRENT	<= 3.5 mA
INSULATION CLASS	B
TYPE OF PROTECTION	IP54
PROTECTION CLASS	I
POWER FACTOR CORRECTION	PASSIVE
OPERATING TEMPERATURE	-25~+60 °C (REF.)
STORAGE TEMPERATURE	-40~+70 °C (REF.)
EMC	EN61000-6-2/3 , EN61000-3-2/3
SAFETY	* UL , cUL , TUV
LIFE EXPECTANCE	* 60,000 HOURS CONTINOUS OPERATION AT 40 °C WITH 15 ~ 65 %RH.
FUNCTIONS	- CONTROL INPUT 0-10VDC or PWM PATTERN or 4-20mA - OUTPUT +10VDC(±10%), max. 10mA - CONTROL VOLTAGE OUTPUT, 0-10VDC - RS485 CONTROL BUS - ALARM RELAY, LOCKED ROTOR PROTECTION, SOFT START - SPEED TELLING, FREQUENCY GENERATOR SIGNAL - VOLTAGE/CURRENT MONITORING

PART NO:

DELTA MODEL: GTB040PUD27R

4. P & Q CURVE:

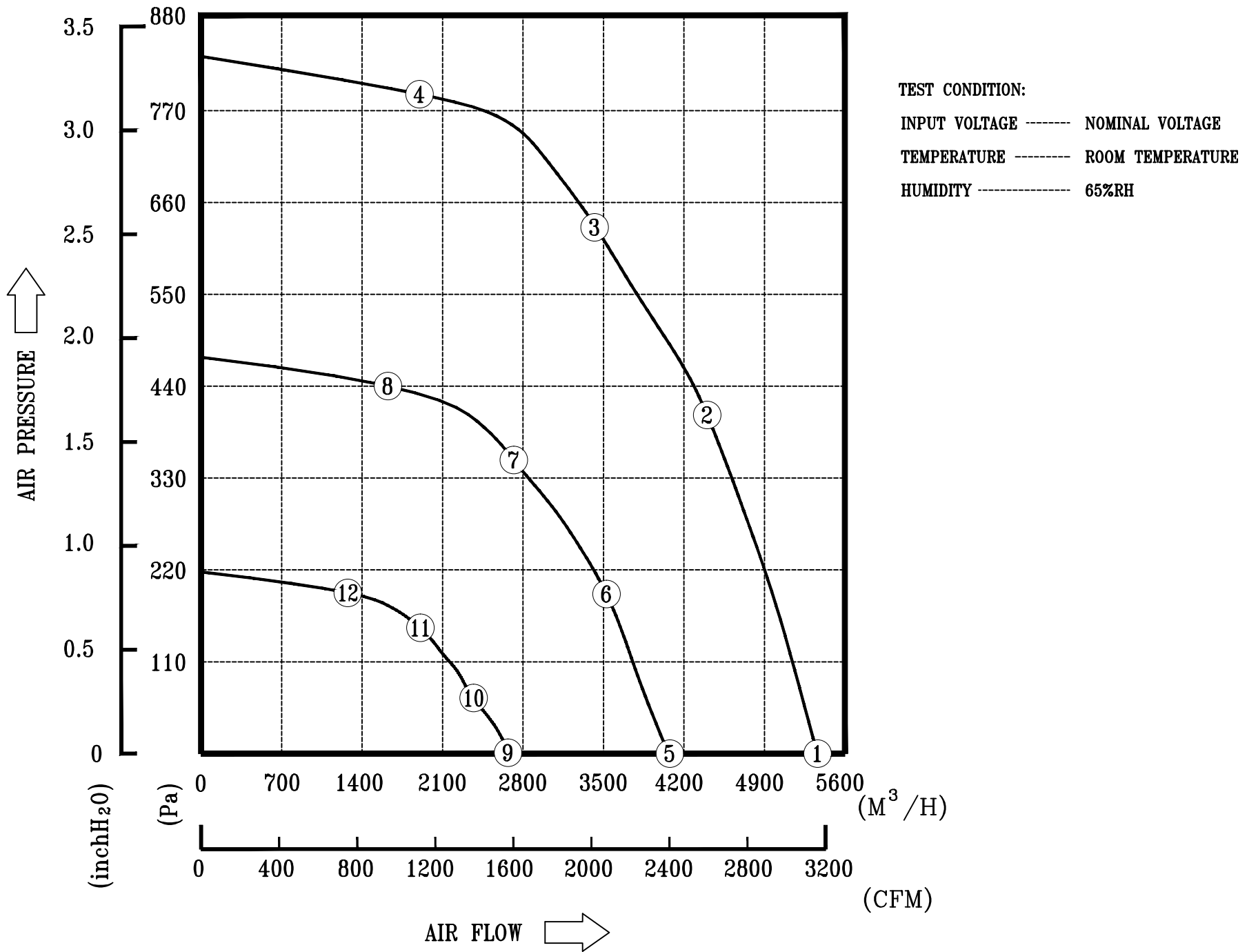

MEASURED DATA:

	P	Q	N	P1	I	Lp
	[Pa]	[M ³ /H]	[R.P.M.]	[W]	[A]	[dB(A)]
1	0	5270	2120	690	1.26	81.0
2	415.5	4371	2116	950	1.63	
3	626.2	3448	2114	1000	1.72	
4	786.0	2048	2119	910	1.56	
5	0	4045	1610	316	0.65	73.1
6	197.0	3514	1605	393	0.81	
7	344.0	2741	1605	440	0.86	
8	441.0	1942	1608	430	0.86	
9	0	2669	1071	101	0.26	64.3
10	78.4	2304	1065	126	0.31	
11	156.8	1852	1070	143	0.33	
12	195.0	1348	1070	141	0.33	

PART NO:

DELTA MODEL: GTB040PUD27R

5. DIMENSION DRAWING:

LABEL

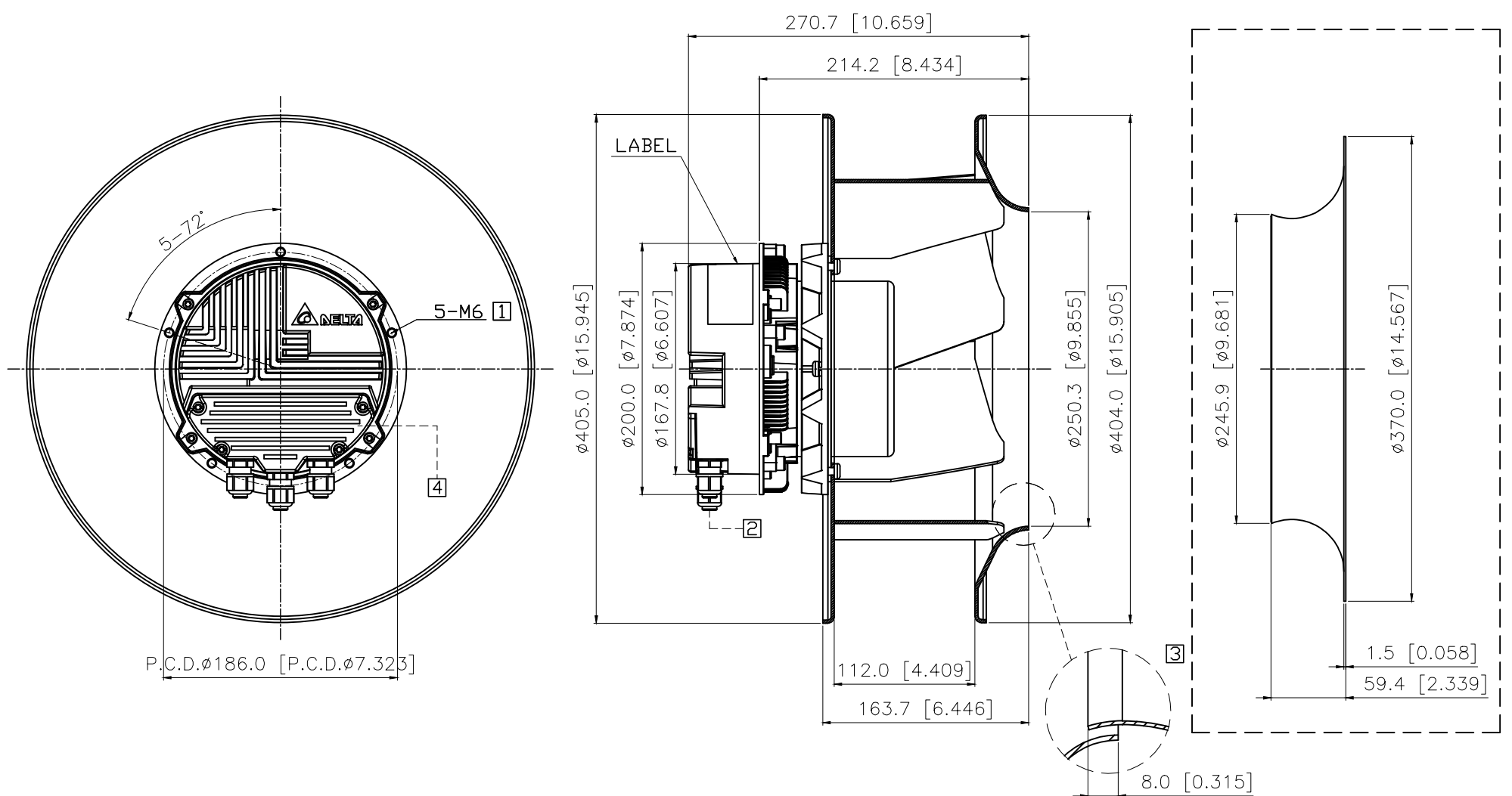
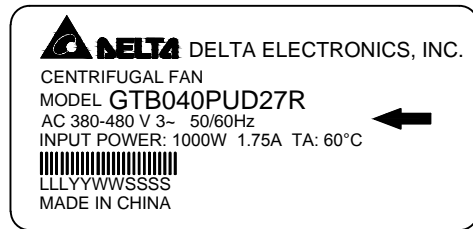

UNIT: mm [INCH]

NOTE:

- ① DEPTH OF SCREW: 12~16mm.
- ② CABLE DIAMETER: $\phi 6.0 \sim \phi 10.0$ mm.
- ③ ACCESSORY: INLET NOZZLE, ALL THE PERFORMANCE DATA ARE MEASURED WITH IT.
- ④ OPEN THE COVER AND REFER TO DEFINITION OF TERMINAL BLOCK.
- ⑤ THIS PRODUCT IS RoHS COMPLIANT.

PART NO:

DELTA MODEL: GTB040PUD27R

6. DEFINITION OF TERMINAL BLOCK:

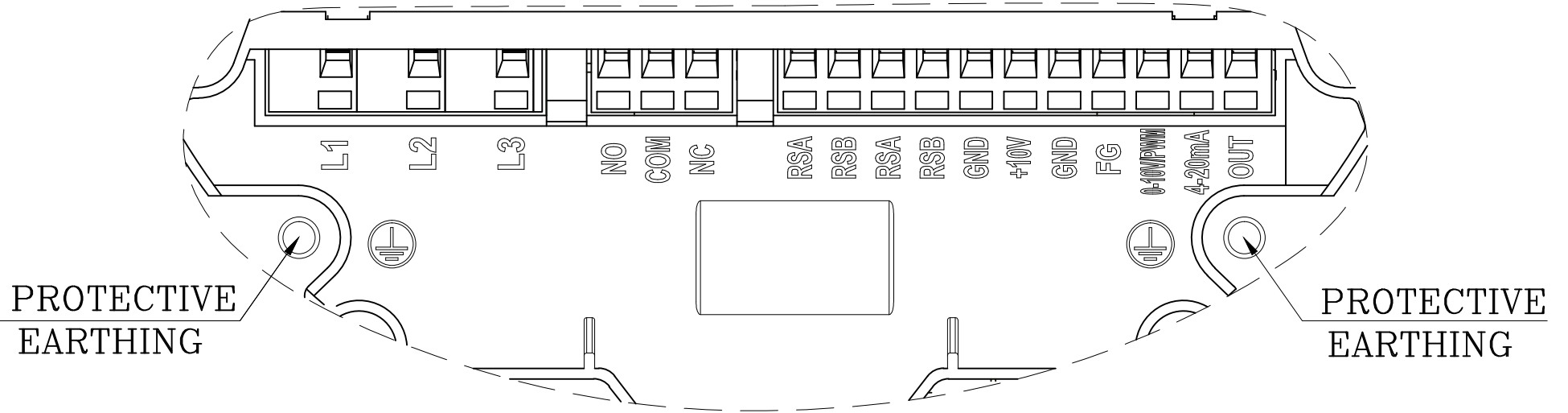

TEXT	FUNCTIONS
L1	AC MAINS
L2	AC MAINS
L3	AC MAINS
NO	ALARM RELAY, CLOSE BY FAILURE
COM	ALARM RELAY, COMMON(2A/250VAC)
NC	ALARM RELAY, OPEN BY FAILURE
RSA	RS485-A
RSB	RS485-B
RSA	RS485-A
RSB	RS485-B
GND	GROUND
+10V	+10V OUTPUT, MAX 10mA (FOR EXTERNAL POTENTIOMETER)
GND	GROUND
FG	FREQUENCY GENERATOR (FG) SIGNAL
0-10V/PWM	SPEED CONTROL, INPUT 0-10VDC
4-20mA	SPEED CONTROL, INPUT 4-20mA
OUT	CONTROL VOLTAGE OUTPUT 0-10VDC (FOR EXTERNAL POTENTIOMETER)

PART NO:

DELTA MODEL: GTB040PUD27R

7. LEAD WIRE CONNECTION:

SPEED CONTROL APPLICATION
(CHOOSE ONE TO USE)

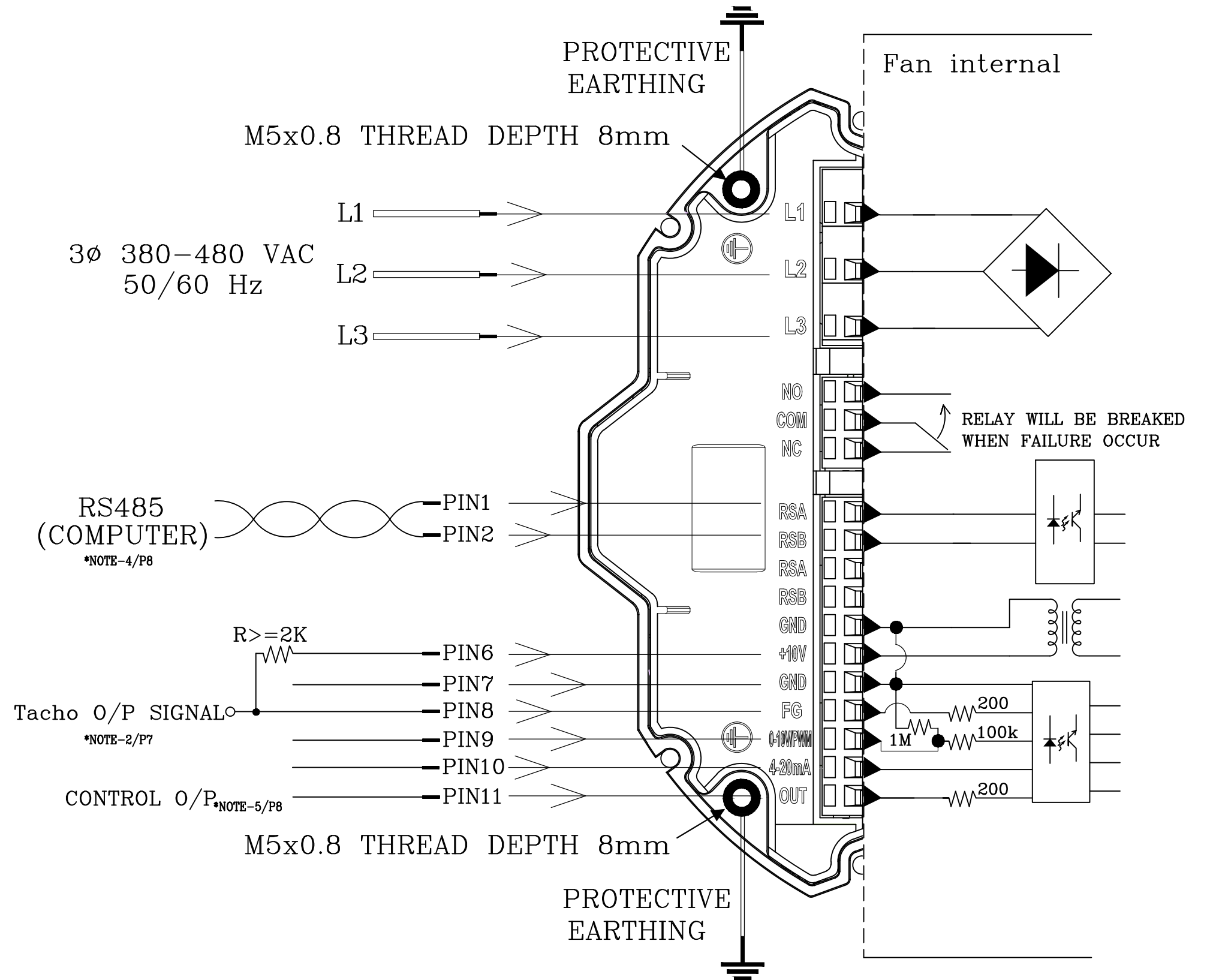
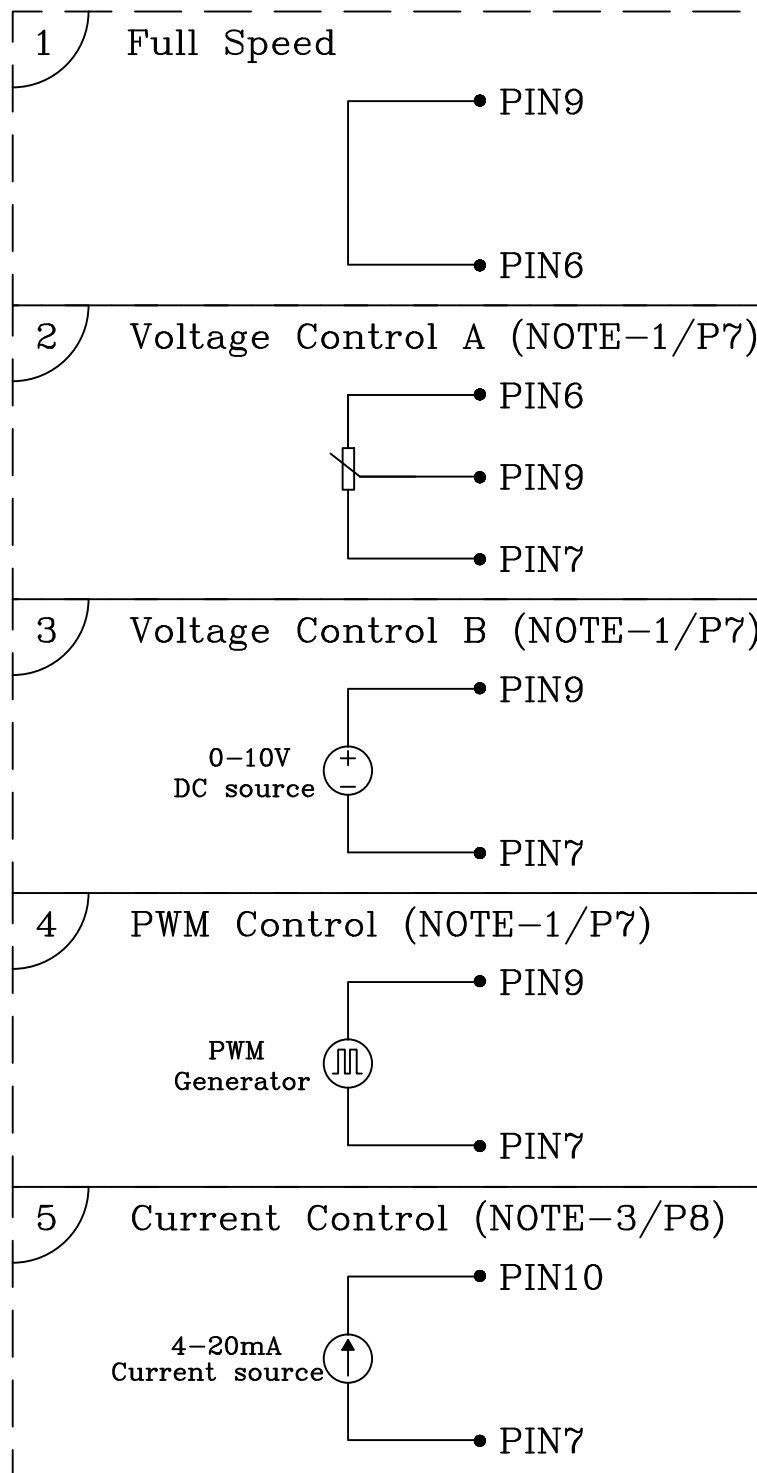

PART NO:

DELTA MODEL: GTB040PUD27R

8. SPEED CONTROL SIGNAL: VOLTAGE CONTROL *NOTE-1

- THERE ARE TWO WAYS TO CONTROL SPEED AND MUST OPEN 4-20mA INPUT.

A. VOLTAGE CONTROL

- CONTROL VOLTAGE RANGE SHALL BE 0-10 VDC.
- VOLTAGE AT 10 VDC THE FAN WILL SPIN AT MAXIMUM SPEED.
- VOLTAGE HIGHER THAN 1.5 VDC, THE FAN WILL START UP.
- VOLTAGE LOWER THAN 0.5 VDC, THE FAN WILL STOP.

B. PWM CONTROL

- THE AMPLITUDE VOLTAGE SHALL BE 10VDC. (100Hz~100kHz)

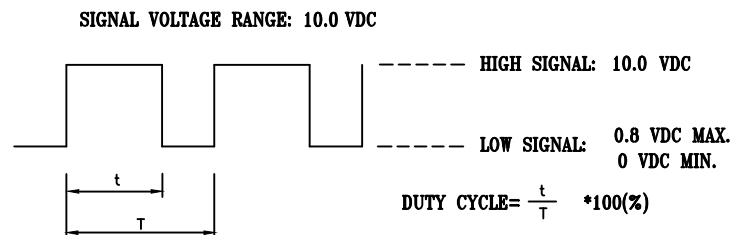

- PWM DUTY HIGHER THAN 15 % , THE FAN WILL START UP.
- PWM DUTY LOWER THAN 5 % , THE FAN WILL STOP.

- THE SPEED COMPARISON WITH CONTROL LEVEL:

VOLTAGE(V)	PWM DUTY(%)	SPEED (R.P.M.) (REF.)
0.0	0	0
1.5	15	380
6.0	60	1420
9.5	95	2140

*NOTE-2: FREQUENCY GENERATOR (FG) SIGNAL

$V_{CE} \text{ (sat)} = 0.7V \text{ MAX.}$

$V_{FG} = 30.0V \text{ MAX.}$

$I_c = 5mA \text{ MAX.}$

$R \geq V_{FG} / I_c$

FREQUENCY GENERATOR WAVEFORM

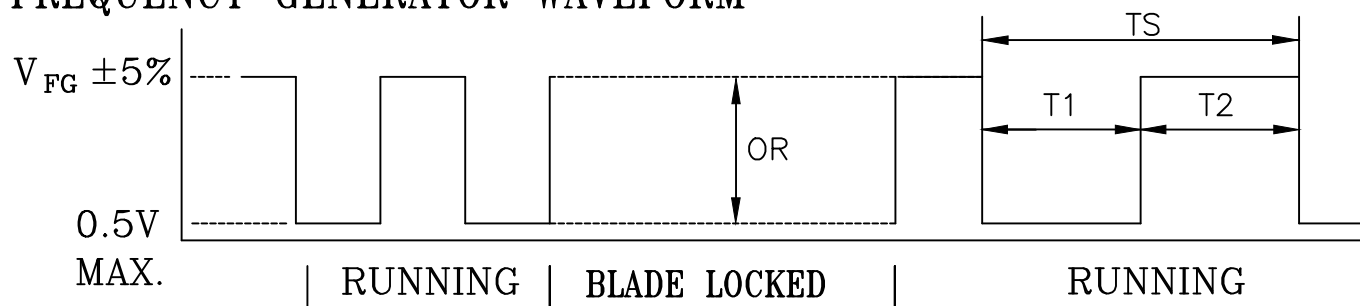

$N = \text{R.P.M}$	1 PULSE PER REVOLUTION
$TS = 60/N(\text{SEC})$	$T1 = T2 = 1/2 TS$

PART NO:

DELTA MODEL: GTB040PUD27R

9. SPEED CONTROL SIGNAL: CURRENT CONTROL *NOTE-3

- SPEED CAN BE CONTROLLED BY CURRENT LEVEL AND MUST OPEN 0-10V/PWM INPUT.
- CONTROL VOLTAGE RANGE SHALL BE 4.0-20 mA.
- CURRENT HIGHER THAN 19.5 mA, THE FAN WILL SPIN AT MAXIMUM SPEED.
- CURRENT HIGHER THAN 6.0 mA, THE FAN WILL START UP.
- CURRENT LOWER THAN 4.5 mA, THE FAN WILL STOP.

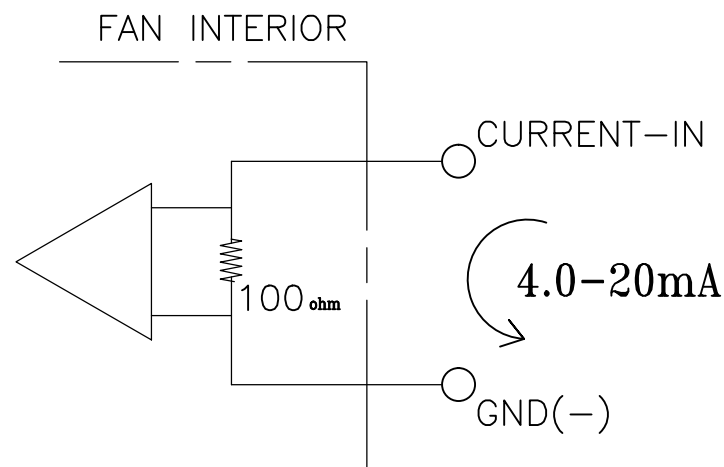

- THE SPEED COMPARISON WITH CONTROL LEVEL:

CURRENT(mA)	SPEED (R.P.M.) _(REF.)
4.0	0
6.3	380
14.0	1450
19.5	2140

10. FUNCTION CONTROL: RS485 CONTROL

*NOTE-4: RS485 CONTROL FUNCTION

- SELECT THE CONTROL MODE OF SPEED, FIXED SPEED OR FIXED PWM DUTY.
- SPEED AND POWER CONSUMPTION FEEDBACK.
- ALLOW MULTIPLE FANS CONTROL AND STATUS PATROL.

11. CONTROL O/P *NOTE-5

- THIS ANALOG SIGNAL LEVEL IS THE DERIVATIVE OF CURRENT CONTROL LEVEL.
- THE SIGNAL WILL BE 0-10 VDC.

CURRENT(mA)	CONTROL O/P(VDC) _(REF.)
4.0	0
6.3	1.54
14.0	6.15
19.5	9.33

PART NO:

DELTA MODEL: GTB040PUD27R

12. CONTROL VOLTAGE(PWM DUTY) & SPEED CURVE:
(SPEED CONTROL PIN)

